

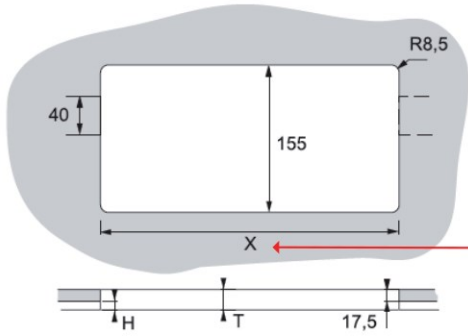

NETBOX Axial / Axial Comfort



H= T- 17mm (Öffnungswinkel = 60°)
H= T- 25mm (Öffnungswinkel = 45°)

X		
Maße:	Siehe Seite 2	
Measures:	See page 2	
Mesures:	Voir page 2	

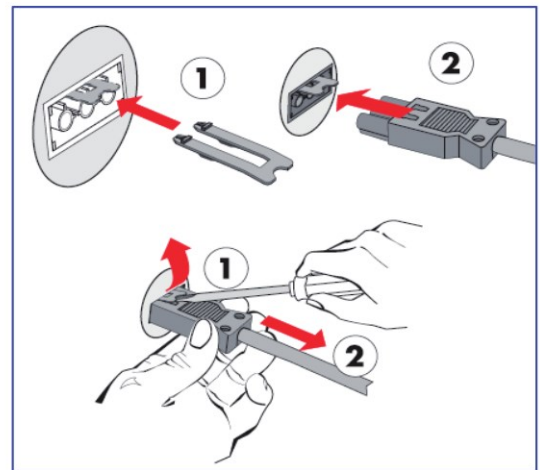
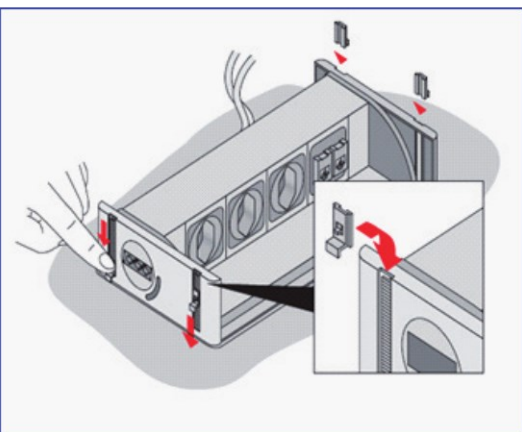
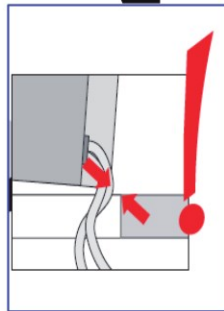
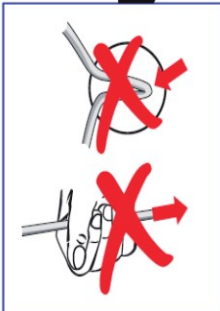
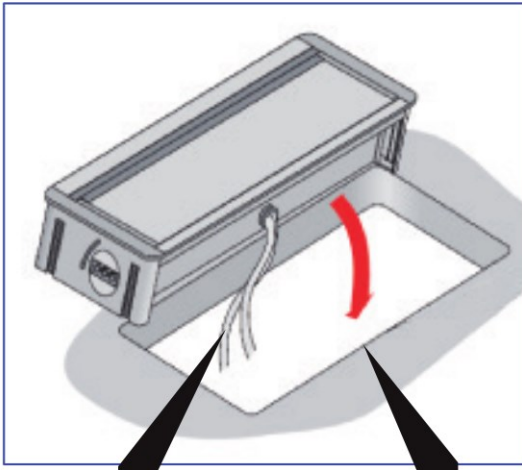

Axial

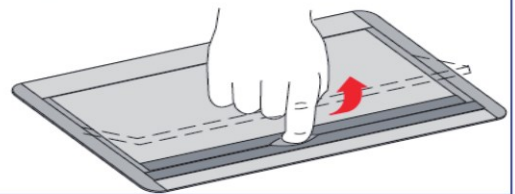

Axial Comfort

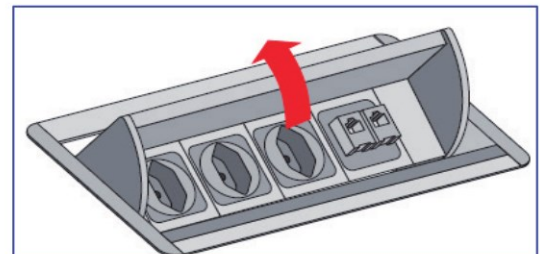
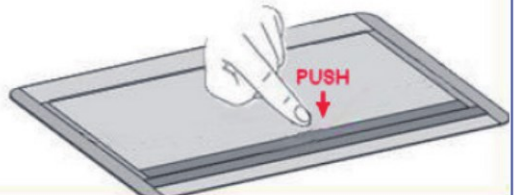

4x Art.Nr.: 4307000103 für Nachbestellungen
Art.nr.: 4307000103 for repeat order

Bedienung und Installation siehe Rückseite!
Operation and installation see at the back!

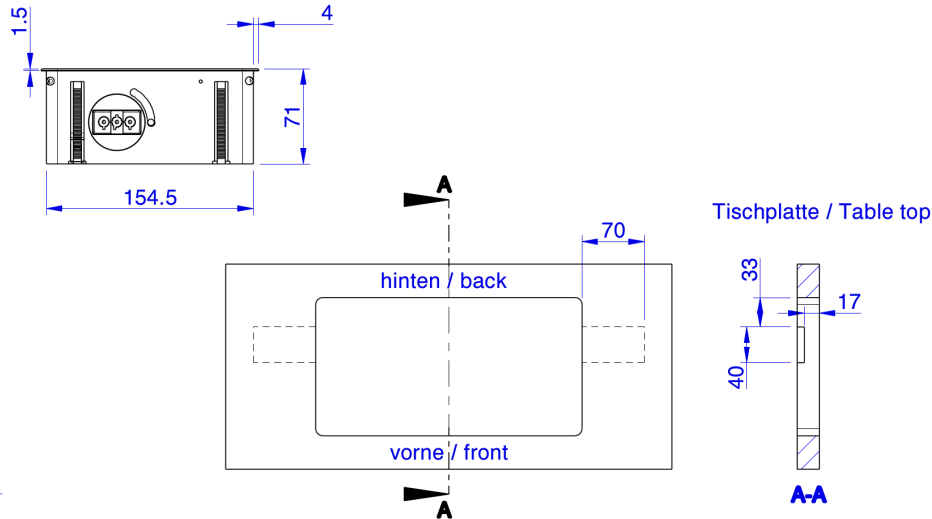

Ausrüstung für Steckverbinder
70mm lang, 40mm breit

Cut-out for connectors
70mm long, 40mm wide

für einen Öffnungswinkel von 60°
X = vorhandene Plattenstärke-17mm

for an opening angle of 60°
X = actual table thickness - 17mm

für einen Öffnungswinkel von 45°
X = vorhandene Plattenstärke-25mm

for an opening angle of 45°
X = actual table thickness - 25mm

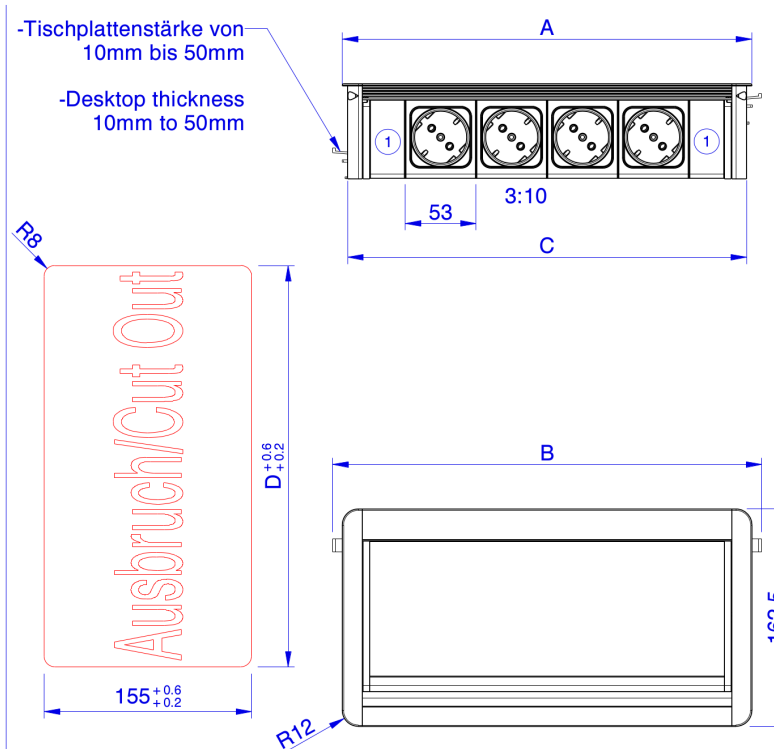
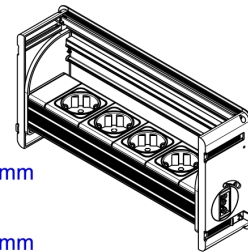

Art.Nr	2X 3	2X 4	2X 5	2X 6	2X 7	2X 8	2X 9	2X A	2X B	= Artikelnummer	Product code
M	2	3	4	5	6	7	8	9	10	= Anzahl der Module	Quantity of outlet modules
A	200	253	306	359	412	465	518	571	624	= Gesamtlänge der Box	Total length
B	214,5	267,5	320,5	373,5	426,5	479,5	532,5	585,5	638,5	= Länge der Box mit Befestigung	Total length with mounting
C	192	245	298	351	404	457	510	563	616	= Einbaulänge	Installation length
D	192.5	245.5	298.5	351.5	404.5	457.5	510.5	563.5	616.5	= Länge des Ausbruchs	Length of cut-out